

FEATURES

- Smallest in its class, it is extremely compact at approx. 2/3 the size of previous products.
Compared to our previous miniature type CT relay, the 1 Form C as well as the 10-pin and 8-pin twin types take up approx. two-thirds the space and volume.
- High-capacity 25 A load switching
High capacity control capable of motor lock load switching at 25 A, 14 V DC is possible despite contact size.
- Pin in Paste (PiP)* compatible model added
Models compatible with the recently increasingly popular PiP technique (reflow solder mounting) have been added.
PiP compatible models are the flux tight type.
* The PiP method may sometimes be referred to as THR (Through-Hole Reflow).
- Environmental protection specifications
Cadmium-free contacts and use of lead-free solder are standard. Environmental pollutants are not used.

TYPICAL APPLICATIONS

- Power windows
- Automatic door locks
- Power mirrors
- Power sunroofs
- Power seats
- Lift gates
- Smart junction box related products, etc.

ORDERING INFORMATION

Ex. A CJ 1 1 12 P

Product name	Contact arrangement	Pick-up voltage (V DC)	Coil voltage (V DC)	Coil voltage (V DC)
CJ	1: 1 Form C 2: 1 Form C × 2 (8 terminals type) 5: 1 Form C × 2 (10 terminals type)	1: Max. 6.5 V DC 2: Max. 7.2 V DC	12: 12	Nil: Standard type P : Pin in Paste type

Standard packing: 1 Form C: Tube: 70 pcs.; Outer carton: 2,800 pcs.
1 Form C × 2, 8 terminals: Tube: 40 pcs.; Outer carton: 1,000 pcs.
1 Form C × 2, 10 terminals: Tube: 35 pcs.; Outer carton: 1,400 pcs.

TYPES

Contact arrangement	Nominal coil voltage	Pick-up voltage (at 20°C 68°F)	Part No.	
			Standard type	Pin in Paste type
1 Form C	12 V DC	Max.6.5 V DC (Initial)	ACJ1112	ACJ1112P
		Max.7.2 V DC (Initial)	ACJ1212	ACJ1212P
1 Form C × 2 (8 terminal)		Max.6.5 V DC (Initial)	ACJ2112	ACJ2112P
		Max.7.2 V DC (Initial)	ACJ2212	ACJ2212P
1 Form C × 2 (10 terminal)		Max.6.5V DC (Initial)	ACJ5112	ACJ5112P
		Max.7.2 V DC (Initial)	ACJ5212	ACJ5212P

RATING

1. Coil data

Nominal coil voltage	Pick-up voltage (at 20°C 68°F)	Drop-out voltage (at 20°C 68°F)	Nominal operating current [±10%] (at 20°C 68°F)	Coil resistance [±10%] (at 20°C 68°F)	Nominal operating power (at 20°C 68°F)	Max. continuous voltage*
12 V DC	Max. 7.2 V DC (Initial)	Min. 1.0 V DC (Initial)	53.3 mA	225Ω	640 mW	10 to 16 V DC
	Max. 6.5 V DC (Initial)	Min. 0.8 V DC (Initial)	66.7 mA	180Ω	800 mW	9 to 16 V DC

* Other usable voltage range types are also available. Please contact us for details.

CJ (ACJ)

2. Specifications

Characteristics	Item	Specifications	
Contact	Arrangement	1 Form C, 1 Form C×2	
	Initial contact resistance (Initial)	N.O.: Typ7mΩ, N.C.: Typ10mΩ (By voltage drop 6 V DC 1 A)	
	Contact material	Ag alloy (Cadmium free)	
Protective construction		Standard type: Sealed type Pin in Paste type: Flux tight type	
Rating	Nominal switching capacity	N.O.: 20A 14V DC, N.C.: 10A 14V DC	
	Max. carrying current (14V DC)	N.O.: 20 A for 1 hour, 30 A for 2 minutes (at 20°C 68°F)	
	Nominal operating power	640 mW (for pick-up voltage max. 7.2 V DC), 800 mW (for pick-up voltage max. 6.5 V DC)	
	Min. switching capacity ¹	1A 12V DC	
Electrical characteristics	Initial insulation resistance		Min. 100 MΩ (at 500 V DC)
	Initial breakdown voltage	Between open contacts	500 Vrms for 1 min. (Detection current: 10mA)
		Between contacts and coil	500 Vrms for 1 min. (Detection current: 10mA)
	Operate time (at nominal voltage)		Max. 10ms (at 20°C 68° F, excluding contact bounce time) (Initial)
	Release time (at nominal voltage)		Max. 10ms (at 20°C 68° F, excluding contact bounce time) (Initial)
Mechanical characteristics	Shock resistance	Functional	Min. 100 m/s ² {10G} (Half-wave pulse of sine wave: 11ms; detection: 10μs)
		Destructive	Min. 1,000 m/s ² {100G} (Half-wave pulse of sine wave: 6ms)
	Vibration resistance	Functional	10 Hz to 100 Hz, Min. 44.1m/s ² {4.5G} (Detection time: 10μs)
		Destructive	10 Hz to 500 Hz, Min. 44.1m/s ² {4.5G} Time of vibration for each direction; X, Y direction: 2 hours, Z direction: 4 hours
Expected life	Mechanical	Min. 10 ⁷ (at 120 cpm)	
	Electrical	[Standard type] <Resistive load> Min. 10 ⁵ (At nominal switching capacity, operating frequency: 1s ON, 9s OFF) <Motor load> N.O. side: Min. 2×10 ⁵ : at 25 A (inrush), 5 A (steady), 14 V DC; Min. 10 ⁵ : at 25 A 14 V DC (Motor lock) N.C. side: Min. 2×10 ⁵ : at 20 A 14 V DC (brake) (Operating frequency: 0.5s ON, 9.5s OFF) [Pin in Paste type] <Resistive load> Min. 10 ⁵ (At nominal switching capacity, operating frequency: 1s ON, 9s OFF) <Motor load> N.O. side: Min. 10 ⁵ : at 25 A (inrush), 5 A (steady), 14 V DC; Min. 5×10 ⁴ : at 25 A 14 V DC (Motor lock) N.C. side: Min. 10 ⁵ : at 20 A 14 V DC (brake) (Operating frequency: 0.5s ON, 9.5s OFF)	
Conditions	Conditions for operation, transport and storage ²	Ambient temp: -40°C to +85°C -40°F to +185°F Humidity: 5% R.H. to 85% R.H. (Not freezing and condensing at low temperature)	
	Max. operating speed	6 cpm (At nominal switching capacity)	
Unit weight	1 Form C type: approx. 3.5 g .12 oz Twin type: approx. 6.5 g .23 oz		

Notes:

*1 This value can change due to the switching frequency, environmental conditions, and desired reliability level, therefore it is recommended to check this with the actual load.

*2 Please inquire if you will be using the relay in a high temperature atmosphere (110°C 230°F).

Refer to "6. Usage, Storage and Transport Conditions" in [AMBIENT ENVIRONMENT section in Relay Technical Information](#).

REFERENCE DATA

1-(1). Coil temperature rise (at room temperature)

Sample: ACJ1212, 3pcs
Measured portion: Inside the coil
Contact carrying current: 10A, 15A, 20A
Ambient temperature: 25°C 77°F

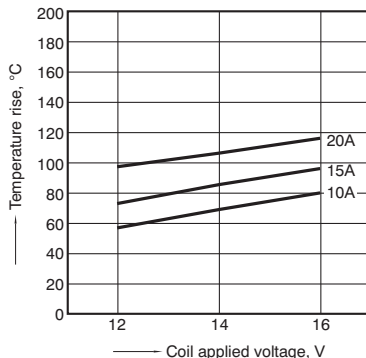

1-(2). Coil temperature rise (at 85°C 185°F)

Sample: ACJ1212, 3pcs
Measured portion: Inside the coil
Contact carrying current: 10A, 15A, 20A
Ambient temperature: 85°C 185°F

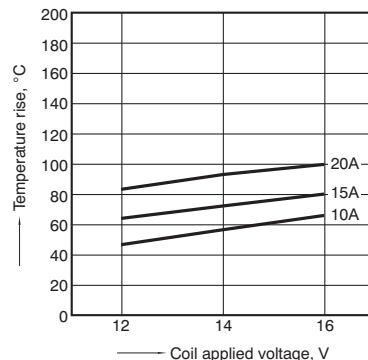

1-(3). Coil temperature rise (at room temperature)

Sample: ACJ2212, 3pcs
Measured portion: Inside the coil
Contact carrying current: 10A, 15A, 20A
Ambient temperature: 25°C 77°F

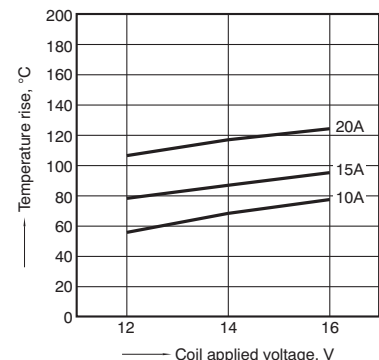

1-(4). Coil temperature rise (at 85°C 185°F)

Sample: ACJ2212, 3pcs
 Measured portion: Inside the coil
 Contact carrying current: 10A, 15A, 20A
 Ambient temperature: 85°C 185°F

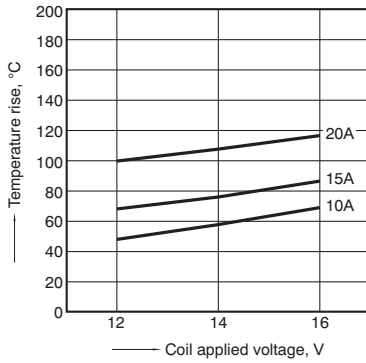

1-(5). Coil temperature rise (at room temperature)

Sample: ACJ5212, 3pcs
 Measured portion: Inside the coil
 Contact carrying current: 10A, 15A, 20A
 Ambient temperature: 25°C 77°F

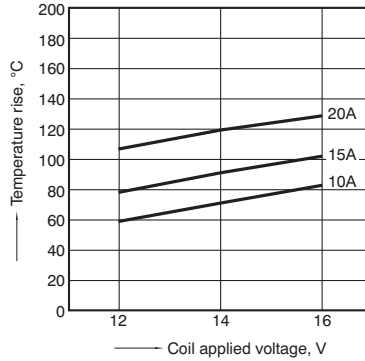

1-(6). Coil temperature rise (at 85°C 185°F)

Sample: ACJ5212, 3pcs
 Measured portion: Inside the coil
 Contact carrying current: 10A, 15A, 20A
 Ambient temperature: 85°C 185°F

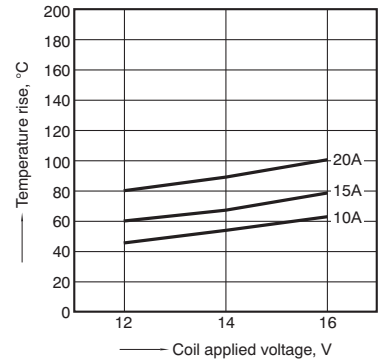

2-(1). Electrical life test (Motor free)

Sample: ACJ2212, 3pcs; Load: Inrush current: 25A/
 Steady current: 5A, Power window motor actual load
 (free condition); Tested voltage: 14V DC; Switching
 frequency: (ON:OFF = 0.5s:9.5s); Switching cycle:
 2x10⁵; Ambient temperature: Room temperature
 Circuit

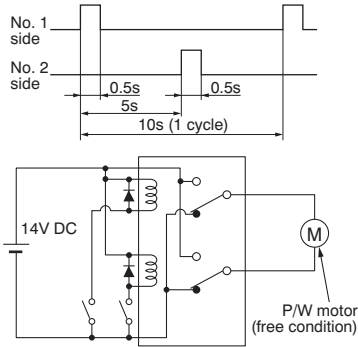

Change of pick-up and drop-out voltage

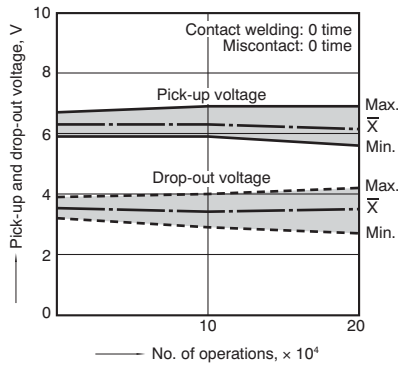

Change of contact resistance

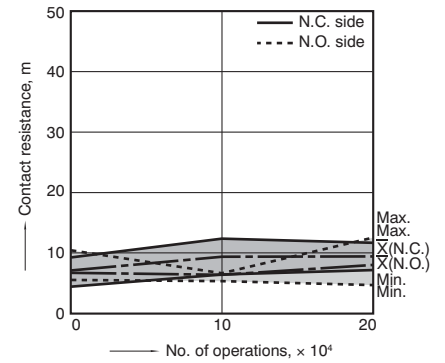

Load current waveform

Inrush current: 25A, Steady current: 6A,
 Brake current: 13A

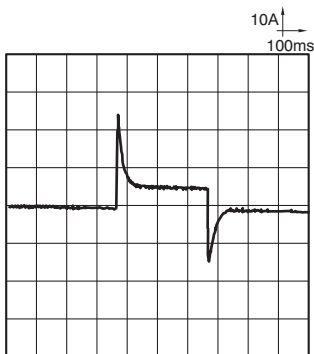

CJ (ACJ)

2-(2). Electrical life test (Motor lock)

Sample: ACJ2212, 3pcs; Load: Steady current: 25A,
Power window motor actual load (lock condition);
Tested voltage: 14V DC; Switching frequency:
(ON:OFF = 0.5s:9.5s); Switching cycle: 10⁵;
Ambient temperature: Room temperature

Circuit

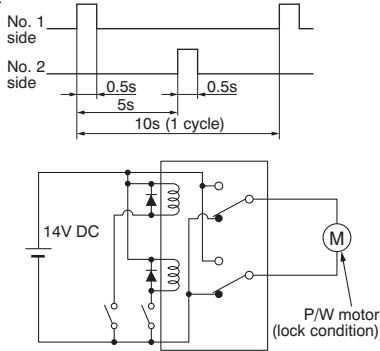

Change of pick-up and drop-out voltage

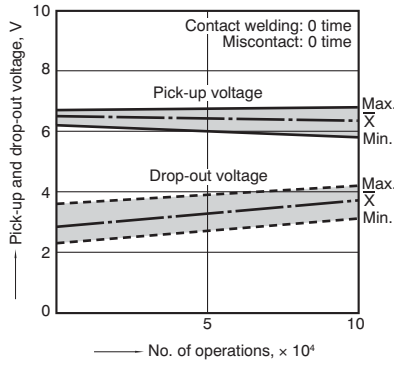

Change of contact resistance

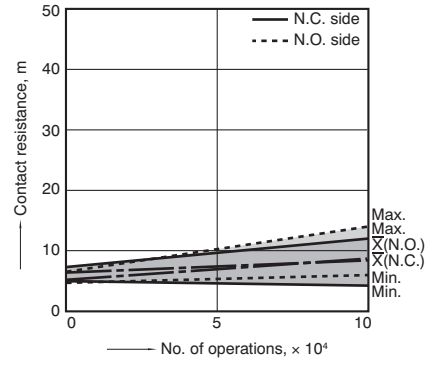

Load current waveform

Current value: 25A

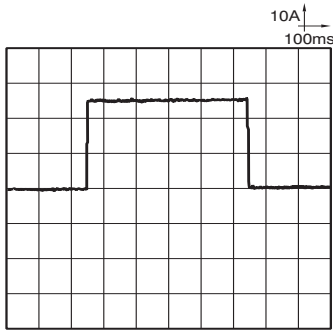

DIMENSIONS (mm inch)

1. Twin type (8-pin)

Standard type

[CAD Data](#)



External dimensions

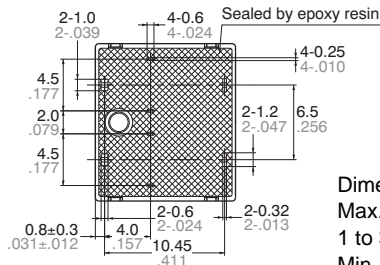
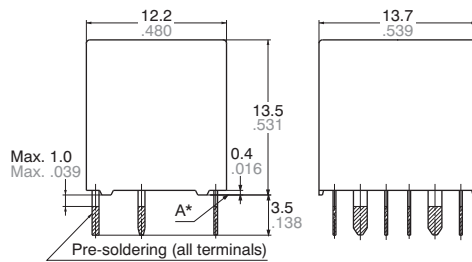

Dimension:
Max. 1mm .039 inch:
1 to 3mm .039 to .118 inch:
Min. 3mm .118 inch:

Tolerance
±0.1 ±.004
±0.2 ±.008
±0.3 ±.012

Download [CAD Data](#) from our Web site.

PC board pattern (Bottom view)

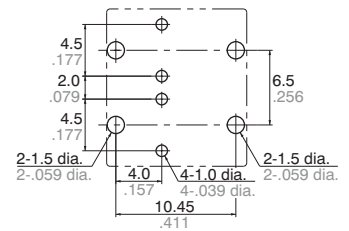

Tolerance: ±0.1 ±.004

Schematic (Bottom view)

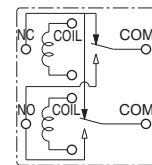

* Dimensions (thickness and width) of terminal specified in this catalog is measured before pre-soldering. Intervals between terminals is measured at A surface level.

2. Twin type (8-pin) Pin in Paste type

[CAD Data](#)



External dimensions

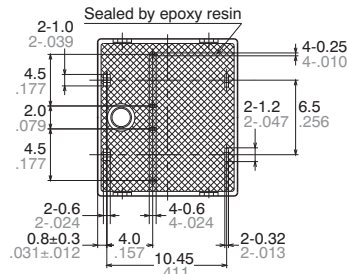
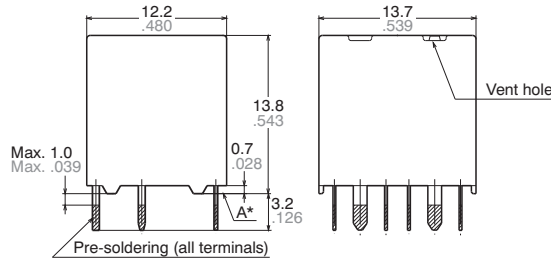

Dimension:
 Max. 1mm .039 inch: $\pm 0.1 \pm 0.04$
 1 to 3mm .039 to .118 inch: $\pm 0.2 \pm 0.08$
 Min. 3mm .118 inch: $\pm 0.3 \pm 0.12$

PC board pattern (Bottom view)

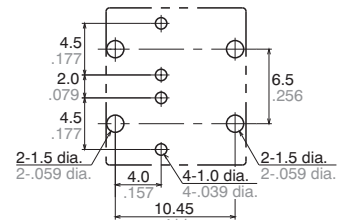

Tolerance: $\pm 0.1 \pm 0.04$

Schematic (Bottom view)

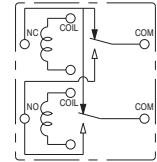

* Dimensions (thickness and width) of terminal specified in this catalog is measured before pre-soldering. Intervals between terminals is measured at A surface level.

3. Twin type (10-pin) Standard type

[CAD Data](#)



External dimensions

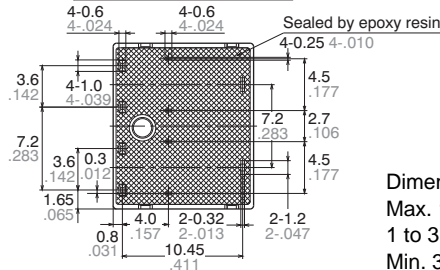
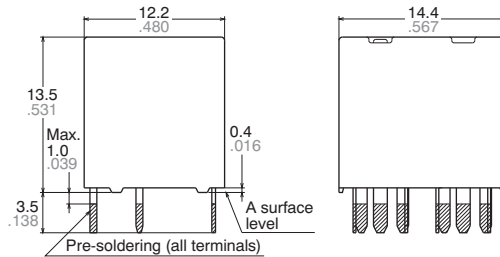

Dimension:
 Max. 1mm .039 inch: $\pm 0.1 \pm 0.04$
 1 to 3mm .039 to .118 inch: $\pm 0.2 \pm 0.08$
 Min. 3mm .118 inch: $\pm 0.3 \pm 0.12$

PC board pattern (Bottom view)

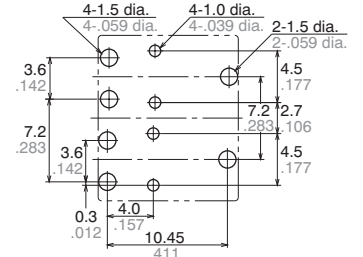

Tolerance: $\pm 0.1 \pm 0.04$

Schematic (Bottom view)

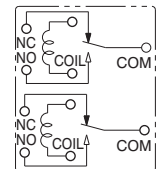

4. Twin type (10-pin) Pin in Paste type

[CAD Data](#)



External dimensions

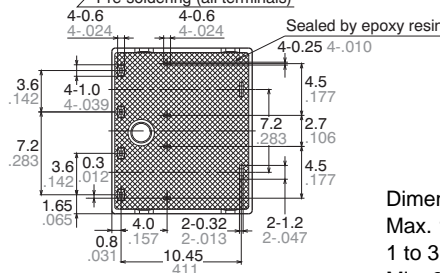
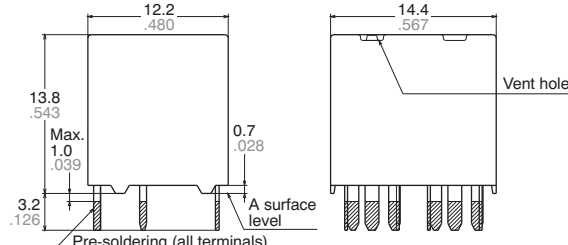

Dimension:
 Max. 1mm .039 inch: $\pm 0.1 \pm 0.04$
 1 to 3mm .039 to .118 inch: $\pm 0.2 \pm 0.08$
 Min. 3mm .118 inch: $\pm 0.3 \pm 0.12$

PC board pattern (Bottom view)

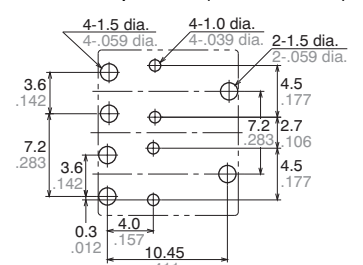

Tolerance: $\pm 0.1 \pm 0.04$

Schematic (Bottom view)

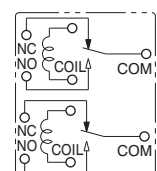

CJ (ACJ)

5. Slim 1 Form C Standard type

[CAD Data](#)



External dimensions

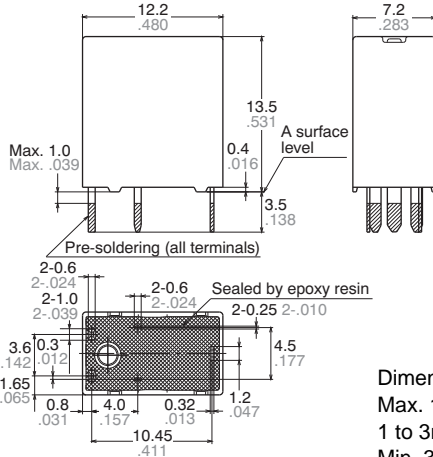

Dimension:	Tolerance
Max. 1mm .039 inch:	$\pm 0.1 \pm 0.004$
1 to 3mm .039 to .118 inch:	$\pm 0.2 \pm 0.008$
Min. 3mm .118 inch:	$\pm 0.3 \pm 0.012$

PC board pattern (Bottom view)

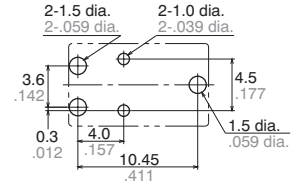

Tolerance: $\pm 0.1 \pm 0.004$

Schematic (Bottom view)

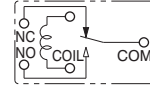

6. Slim 1 Form C Pin in Paste type

[CAD Data](#)



External dimensions

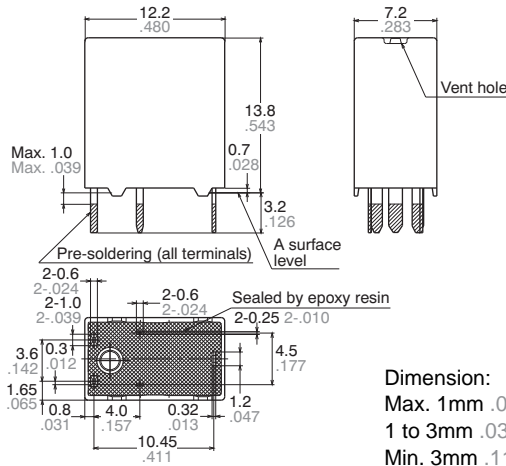

Dimension:	Tolerance
Max. 1mm .039 inch:	$\pm 0.1 \pm 0.004$
1 to 3mm .039 to .118 inch:	$\pm 0.2 \pm 0.008$
Min. 3mm .118 inch:	$\pm 0.3 \pm 0.012$

PC board pattern (Bottom view)

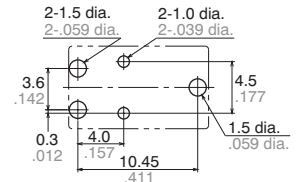

Tolerance: $\pm 0.1 \pm 0.004$

Schematic (Bottom view)

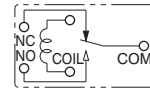

EXAMPLE OF CIRCUIT

Forward/reverse control circuits of DC motor (for 1 Form C \times 2 (8 terminal) type)

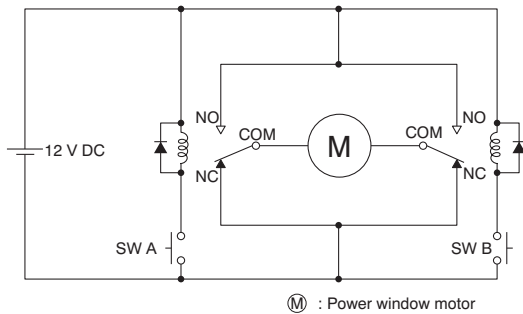

For Cautions for Use, see [Relay Technical Information](#).