

### High voltage DC, High capacity Cut-off Relays using Capsule Contact Mechanism

# EV RELAYS

<Protective construction>  
Capsule contact

#### Normal types

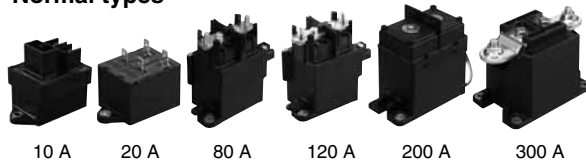

#### Compact high short-circuit capacity type

New



#### Quiet types



Vertical type



Horizontal type

RoHS compliant

## FEATURES

### • Compact, lightweight and safety

To realize quick gap cutoff with high voltage DC, hydrogen gas, which has superior arc cooling capability, is sealed in the capsule contact chamber. At the same time, superior safety is achieved owing to an explosion-proof construction that prevents arc leakage.

### • High contact reliability

Since the contact portion is sealed in hydrogen gas, there is no contact oxidation. It is also dustproof and waterproof.

### • Richly varied lineup

Types that are quiet in operation types and high short-circuit capacity types are also available. Moreover, the lineup includes plenty of all plug-in types, as well as high carrying current types.

## TYPICAL APPLICATIONS

- Electric vehicles (HEV, PHEV, BEV, and FCV)
- Battery charge and discharge systems
- High voltage DC applications such as hybrid construction equipment

## EV Relay [Normal type]

### ORDERING INFORMATION

AEV   0

Contact arrangement

- 1: 1 Form A (Screw terminal, 10 A TM type)
- 5: 1 Form A (20 A TM type)

Contact rating

- 1: 10 A
- 2: 20 A
- 8: 80 A
- 4: 120 A
- 7: 200 A
- 9: 300 A

Rated coil voltage

- 12: 12 V DC
- 24: 24 V DC

Coil terminal structure

- Nil: Faston terminal (for 20 A type), Connector (for 80 A, 120 A and 300 A), Lead wire (for 200 A)
- 2: Faston terminal (for 10 A type with terminal protection cover)

\* EV80A, EV120A, and EV200A have vertical type, EV120A has high short-circuit capacity type, and high carrying current type (135A, 200A): please inquire our sales representative for more information.

# EV (AEV, AEVG, AEVS)

## TYPES

Contact rating	Contact arrangement	Rated coil voltage	Part No.	Packing	
				Carton	Case
10 A	1 Form A	12V DC	AEV110122	25 pcs.	100 pcs.
20 A			AEV52012	25 pcs.	50 pcs.
80 A			AEV18012	1 pc.	20 pcs.
120 A			AEV14012	1 pc.	20 pcs.
200 A			AEV17012	1 pc.	10 pcs.
300 A			AEV19012	1 pc.	5 pcs.
10 A	1 Form A	24V DC	AEV110242	25 pcs.	100 pcs.
80 A			AEV18024	1 pc.	20 pcs.
120 A			AEV14024	1 pc.	20 pcs.
200 A			AEV17024	1 pc.	10 pcs.
300 A			AEV19024	1 pc.	5 pcs.

## RATING

### 1. Coil data

Contact rating	Rated coil voltage	Operate (Set) voltage (at 20°C 68°F) (initial)	Release (Reset) voltage (at 20°C 68°F) (initial)	Rated operating current [±10%] (at 20°C 68°F)	Rated operating power (at 20°C 68°F)	Max. allowable voltage*2
10 A	12V DC	Max. 9 V DC	Min. 1 V DC	0.103 A	1.24 W	16V DC
20 A*1			Min. 0.5 V DC	0.327 A	3.9 W	
80 A			Min. 1 V DC	0.353 A	4.2 W	
120 A			Min. 1 V DC	0.353 A	4.2 W	
200 A			Min. 1 V DC	0.5 A	6 W	
300 A			Min. 2 V DC	3.2 A (Inrush)	Inrush: 37.9 W (approx. 0.1 sec.) Stable: 3.6 W	
10 A	24V DC	Max. 18 V DC	Min. 2 V DC	0.052 A	1.24 W	32V DC
80 A			Min. 2 V DC	0.176 A	4.2 W	
120 A			Min. 2 V DC	0.176 A	4.2 W	
200 A			Min. 2 V DC	0.25 A	6 W	
300 A			Min. 4 V DC	1.85 A (Inrush)	Inrush: 44.4 W (approx. 0.1 sec.) Stable: 3.8 W	

Notes: \*1. Please inquire our sales representative for more information about EV20A with rated coil voltage of 24V DC.

\*2. Max. continuous applied voltage to the coil is the same as max. allowable voltage.

## 2. Specifications

Item		Specifications		
		10A type	20A type	
Contact data	Contact arrangement	1 Form A		
	Contact material	Molybdenum	Copper alloy	
	Rated switching capacity (resistive)	10A 450V DC	20A 400V DC	
	Max. carrying current	10A Continuity 15A 2 min. 30A 30 sec. (2mm <sup>2</sup> wire)	20A Continuity 40A 10 min. 60A 1 min. (3mm <sup>2</sup> wire)	
	Min. switching load*1	1A 12V DC (resistive, at 20°C 68°F)		
Contact voltage drop (initial)		Max. 0.5V (By voltage drop 10A 6V DC)	Max. 0.2V (By voltage drop 20A 6V DC)	
Insulated resistance (initial)		Min. 100 MΩ (at 500V DC, Measurement at same location as "Dielectric strength" section.)		
Dielectric strength (initial)	Between open contacts	2,500 Vrms for 1 min. (Detection current: 10mA)		
	Between contacts and coil	2,500 Vrms for 1 min. (Detection current: 10mA)		
Time characteristics (initial)	Operate (Set) time (at rated coil voltage)	Max. 50ms (at 20°C 68°F, without contact bounce time)		
	Release (Reset) time (at rated coil voltage)	Max. 30ms (at 20°C 68°F) (Without diode)		
Shock resistance	Functional	For ON: Min. 196m/s <sup>2</sup> {approx. 20 G} (Half-wave pulse of sine wave: 11ms; detection time: 10μs) 10A type for OFF: Min. 196m/s <sup>2</sup> {approx. 20 G} (Half-wave pulse of sine wave: 11ms; detection time: 10μs) 20A type for OFF: Min. 98m/s <sup>2</sup> {approx. 10 G} (Half-wave pulse of sine wave: 11ms; detection time: 10μs)		
	Destructive	Min. 490 m/s <sup>2</sup> {approx. 50 G} (Half-wave pulse of sine wave: 6ms)		
Vibration resistance	Functional	10 to 200 Hz, acceleration: 43 m/s <sup>2</sup> {approx. 4.4G} (Detection time: 10μs)		
	Destructive	10 to 200 Hz, acceleration: 43 m/s <sup>2</sup> {approx. 4.4G} X, Y, Z direction: 4 hours		
Expected life	Mechanical life	Min. 10 <sup>5</sup> (at 60 cpm)	Min. 2 × 10 <sup>5</sup> (at 60 cpm)	
	Electrical life (resistive)*2	10A 400V DC, Min. 75,000 cycles 10A 450V DC, Min. 30,000 cycles	20A 400V DC, Min. 3,000 cycles	
	Switch-off life*2,3	Forward direction	30A 450V DC, Min. 50 cycles	60A 400V DC, Min. 50 cycles
		Reverse direction	—	—
Inrush resistance current (capacitor)	30A 400V DC, Min. 50,000 cycles 15A 450V DC, Min. 70,000 cycles	40A 400V DC, Min. 75,000 cycles		
Conditions	Conditions for usage, transport and storage*4	Ambient temperature: -40 to +80°C -40 to +176°F (Storage: Max. +85°C +185°F), Humidity: 5 to 85% R.H. (Please avoid icing or condensation)		
Weight		Approx. 90 g 3.17 oz	Approx. 180 g 6.35 oz	

Notes: The coil voltage 12V DC type and 24V DC type have the same specifications.

\*1. This value can change due to the switching frequency, environmental conditions, and desired reliability level, therefore it is recommended to check this with the actual load.

\*2. The performance value applies when a varistor is connected in parallel to the coil. Please be warned that working life will be reduced when a diode is used.

\*3. at L/R ≤ 1ms

\*4. The upper operation ambient temperature limit is the maximum temperature that can satisfy the coil temperature rise value. For details, please refer to the "Automotive Relay Users Guide".

# EV (AEV, AEVG, AEVS)

Item		Specifications				
		80A type	120A type	200A type	300A type	
Contact data	Contact arrangement	1 Form A				
	Contact material	Tungsten and copper alloys		Copper alloy		
	Rated switching capacity (resistive)	80A 450V DC	120A 450V DC	200A 450V DC	300A 450V DC	
	Max. carrying current	80A Continuity 120A 15 min. 180A 2 min. (15mm <sup>2</sup> wire)	120A Continuity 225A 3 min. 400A 30 sec. (38mm <sup>2</sup> wire)	200A Continuity 300A 15 min. (60mm <sup>2</sup> wire)	300A Continuity 400A 10 min. (100mm <sup>2</sup> wire)	
	Min. switching load (resistive)*1	1A 12V DC (at 20°C 68°F)			1A 24V DC (at 20°C 68°F)	
	Contact voltage drop (initial)	Max. 0.067V (By voltage drop 20A 6V DC)	Max. 0.03V (By voltage drop 20A 6V DC)	Max. 0.1V (200A carry current)	Max. 0.06V (300A carry current)	
Insulated resistance (initial)		Min. 100 MΩ (at 500V DC, Measurement at same location as "Dielectric strength" section.)				
Dielectric strength (initial)	Between open contacts	2,500 Vrms for 1 min. (Detection current: 10mA)				
	Between contacts and coil	2,500 Vrms for 1 min. (Detection current: 10mA)				
Time characteristics (initial)	Operate (Set) time (at rated coil voltage)	Max. 50ms (at 20°C 68°F, without contact bounce time)			Max. 30ms (at 20°C 68°F, without contact bounce time)	
	Release (Reset) time (at rated coil voltage)	Max. 30ms (at 20°C 68°F) (Without diode)			Max. 10ms (at 20°C 68°F)	
Shock resistance	Functional	For ON: Min. 196m/s <sup>2</sup> {approx. 20 G} (Half-wave pulse of sine wave: 11ms; detection time: 10μs) For OFF: Min. 98m/s <sup>2</sup> {approx. 10 G} (Half-wave pulse of sine wave: 11ms; detection time: 10μs)				
	Destructive	Min. 490 m/s <sup>2</sup> {approx. 50 G} (Half-wave pulse of sine wave: 6ms)				
Vibration resistance	Functional	80A, 120A and 200A type: 10 to 200 Hz: 43 m/s <sup>2</sup> {approx. 4.4G} (Detection time: 10μs)				
		300A type: 10 to 200 Hz: 44.1 m/s <sup>2</sup> {approx. 4.5G} (Detection time: 10μs)				
	Destructive	80A, 120A and 200A type: 10 to 200 Hz: 43 m/s <sup>2</sup> {approx. 4.4G} X, Y, Z direction: 4 h 300A type: 10 to 200 Hz: 44.1 m/s <sup>2</sup> {approx. 4.5G} X, Y, Z direction: 4 h				
Expected life	Mechanical life		Min. 2 × 10 <sup>5</sup> (at 60 cpm)			
	Electrical life (resistive)*2		80A 450V DC, Min. 1,000 cycles	30A 450V DC, Min. 1,000 cycles	200A 450V DC, Min. 3,000 cycles	300A 450V DC, Min. 1,000 cycles
	Switch-off life*2,3	Forward direction	800A 300V DC, Min. 1 cycle 120A 450V DC, Min. 50 cycles	1,200A 300V DC, Min. 1 cycle 120A 450V DC, Min. 50 cycles	2,000A 350V DC, Min. 1 cycle 400A 450V DC, Min. 50 cycles	2,500A 300V DC, Min. 3 cycles*4 600A 450V DC, Min. 50 cycles
		Reverse direction	-120A 200V DC, Min. 50 cycles	-120A 200V DC, Min. 50 cycles	-200A 200V DC, Min. 1,000 cycles	-300A 200V DC, Min. 100 cycles
	Inrush resistance current (capacitor)		150A 20V DC, Min. 70,000 cycles	120A 20V DC, Min. 70,000 cycles	140A 20V DC, Min. 70,000 cycles	240A 20V DC, Min. 70,000 cycles
Conditions	Conditions for usage, transport and storage*5		Ambient temperature: -40 to +80°C <b>-40 to +176°F</b> Humidity: 5 to 85% R.H. (Please avoid icing or condensation)			
Weight		Approx. 400 g <b>14.11 oz</b>		Approx. 600 g <b>21.16 oz</b>	Approx. 750 g <b>26.46 oz</b>	

Notes: The coil voltage 12V DC type and 24V DC type have the same specifications.

\*1. This value can change due to the switching frequency, environmental conditions, and desired reliability level, therefore it is recommended to check this with the actual load.

\*2. The performance value applies when a varistor is connected in parallel to the coil. Please be warned that working life will be reduced when a diode is used.

\*3. at L/R ≤ 1ms

\*4. Condition: Nominal switching 10 cycles, each switch-off 2,500A.

\*5. The upper operation ambient temperature limit is the maximum temperature that can satisfy the coil temperature rise value. For details, please refer to the "Automotive Relay Users Guide".

# EV Relay [Compact high short-circuit capacity type]

## ORDERING INFORMATION

	AEVG			0		
Contact arrangement	1: 1 Form A (Screw terminal)					
Contact rating	6: 60 A					
Rated coil voltage	12: 12V DC					
Coil terminal structure	Nil: Lead wire					

\* There are also all plug-in types: please inquire our sales representative for more information.

## TYPES

Contact rating	Contact arrangement	Rated coil voltage	Part No.	Packing
				Case
60A	1 Form A	12V DC	AEVG16012	40 pcs (Carton 40 pcs./1 tray)

## RATING

### 1. Coil data

Contact rating	Rated coil voltage	Operate (Set) voltage (at 20°C 68°F) (initial)	Release (Reset) voltage (at 20°C 68°F) (initial)	Rated operating current [±10%] (at 20°C 68°F)	Rated operating power (at 20°C 68°F)	Max. allowable voltage*1
60A	12V DC	Max. 9 V DC	Min. 0.5 V DC	0.429A	5.2W	16V DC

Note: \*1. When continually powered, the applied voltage is 14 V DC.

### 2. Specifications

Item		Specifications
Contact data	Contact arrangement	1 Form A
	Contact material	Copper alloy
	Rated switching capacity (resistive)	60A 450V DC
	Max. carrying current	60A Continuity, 120A 5 min., 180A 30 sec. (15mm <sup>2</sup> wire)
	Min. switching load (resistive)*1	1A 12V DC (at 20°C 68°F)
	Contact voltage drop (initial)	Max. 0.15V (By voltage drop 60A 6V DC)
Short circuit capacity		4,500A (at Max. 10 ms), No smoke and no ignition
Insulated resistance (initial)		Min. 100 MΩ (at 1,000V DC, Measurement at same location as "Dielectric strength" section.)
Dielectric strength (initial)	Between open contacts	2,500 Vrms for 1 min. (Detection current: 10mA)
	Between contacts and coil	2,500 Vrms for 1 min. (Detection current: 10mA)
Time characteristics (initial)	Operate (Set) time (at rated coil voltage)	Max. 50ms (at 20°C 68°F, without contact bounce time)
	Release (Reset) time (at rated coil voltage)	Max. 30ms (at 20°C 68°F, without contact bounce time) (Without diode)
Shock resistance	Functional	For ON: Min. 196m/s <sup>2</sup> {approx. 20 G} (Half-wave pulse of sine wave: 11ms; detection time: 10μs) For OFF: Min. 98m/s <sup>2</sup> {approx. 10 G} (Half-wave pulse of sine wave: 11ms; detection time: 10μs)
	Destructive	Min. 490 m/s <sup>2</sup> {approx. 50 G} (Half-wave pulse of sine wave: 6ms)
Vibration resistance	Functional	10 to 200 Hz, 44.1 m/s <sup>2</sup> {approx. 4.5G} (Detection time: 10μs)
	Destructive	10 to 200 Hz, 44.1 m/s <sup>2</sup> {approx. 4.5G} X, Y, Z direction: 4 hours
Expected life	Mechanical life	Min. 2 × 10 <sup>5</sup> (at 60 cpm)
	Switch-off life*2, 3	400A 300V DC, Min. 1 cycles (No polarity)
	Inrush resistance current (capacitor)	30A 450V DC, Min. 70,000 cycles 120A 20V DC, Min. 70,000 cycles
Conditions	Conditions for usage, transport and storage*4	Ambient temperature: -40 to +80°C -40 to +176°F Humidity: 5 to 85% R.H. (Please avoid icing or condensation)
Weight		Approx. 165 g 5.82 oz

Notes: \*1. This value can change due to the switching frequency, environmental conditions, and desired reliability level, therefore it is recommended to check this with the actual load.

\*2. The performance value applies when a varistor is connected in parallel to the coil. Please be warned that working life will be reduced when a diode is used.

\*3. at L/R ≤ 1ms

\*4. The upper operation ambient temperature limit is the maximum temperature that can satisfy the coil temperature rise value. For details, please refer to the "Automotive Relay Users Guide".

## EV Relay [Quiet type]

### ORDERING INFORMATION

AEVS   **0**

Contact arrangement/Installation type

1: 1 Form A (Screw terminal, Vertical type)

9: 1 Form A (Screw terminal, Horizontal type)

Contact rating

6: 60 A

Rated coil voltage

12: 12V DC

Coil terminal structure

Nil: Lead wire

2: Faston terminal

\* There are also all plug-in types and 150A carry current type: please inquire our sales representative for more information.

### TYPES

Contact rating	Contact arrangement	Rated coil voltage	Installation type	Part No.	Packing	
					Carton	Case
60A	1 Form A	12V DC	Vertical type	AEVS16012	1 pc.	20 pcs.
			Horizontal type	AEVS960122		

### RATING

#### 1. Coil data

Contact rating	Rated coil voltage	Operate (Set) voltage (at 20°C 68°F) (initial)	Release (Reset) voltage (at 20°C 68°F) (initial)	Rated operating current [±10%] (at 20°C 68°F)	Rated operating power (at 20°C 68°F)	Max. allowable voltage*1
60A	12V DC	Max. 9 V DC	Min. 1 V DC	0.375A	4.5W	16V DC

Note: \*1. When continually powered, the applied voltage is 14 V DC (at 65°C 149°F).

## 2. Specifications

Item		Specifications		
		Vertical type	Horizontal type	
Contact data	Contact arrangement	1 Form A		
	Contact material	Tungsten and copper alloys		
	Rated switching capacity (resistive)	60A 450V DC		
	Max. carrying current	60A Continuity, 100A 10 min., 180A 1 min. (15mm <sup>2</sup> wire)		
	Min. switching load (resistive)*1	1A 12V DC (at 20°C 68°F)		
	Contact voltage drop (initial)	Max. 0.067V (By voltage drop 20A 6V DC)		
Insulated resistance (initial)		Min. 100 MΩ (at 500V DC, Measurement at same location as "Dielectric strength" section.)		
Dielectric strength (initial)	Between open contacts	2,500 Vrms for 1 min. (Detection current: 10mA)	2,000 Vrms for 1 min. (Detection current: 10mA)	
	Between contacts and coil	2,500 Vrms for 1 min. (Detection current: 10mA)	2,000 Vrms for 1 min. (Detection current: 10mA)	
Time characteristics (initial)	Operate (Set) time (at rated coil voltage)	Max. 50ms (at 20°C 68°F, without contact bounce time)		
	Release (Reset) time (at rated coil voltage)	Max. 50ms (at 20°C 68°F, without contact bounce time) (Without diode)		
Shock resistance	Functional	For ON: Min. 196m/s <sup>2</sup> {approx. 20 G} (Half-wave pulse of sine wave: 11ms; detection time: 10μs) For OFF: Min. 98m/s <sup>2</sup> {approx. 10 G} (Half-wave pulse of sine wave: 11ms; detection time: 10μs)		
	Destructive	Min. 490 m/s <sup>2</sup> {approx. 50 G} (Half-wave pulse of sine wave: 6ms)		
Vibration resistance	Functional	10 to 100 Hz, acceleration: 43 m/s <sup>2</sup> {approx. 4.4G} 10 to 200 Hz, acceleration: 19.6 m/s <sup>2</sup> {approx. 2G} (Detection time: 10μs)		
	Destructive	10 to 100 Hz, acceleration: 43 m/s <sup>2</sup> {approx. 4.4G} 10 to 200 Hz, acceleration: 19.6 m/s <sup>2</sup> {approx. 2G} X, Y, Z direction: 4 hours		
Expected life	Mechanical life		Min. 2 × 10 <sup>5</sup> (at 60 cpm)	
	Electrical life (resistive)		60A 450V DC, Min. 800 cycles	
	Switch-off life*2,3	Forward direction	600A 300V DC, Min. 5 cycles 120A 450V DC, Min. 50 cycles	
		Reverse direction	-120A 200V DC, Min. 50 cycles	
Inrush resistance current (capacitor)		60A 20V DC, Min. 70,000 cycles		
Conditions	Conditions for usage*4		Ambient temperature: -40 to +80°C -40 to +176°F (When continuous steady current at 14 V DC: -40 to +65°C -40 to +149°F) Humidity: 5 to 85% R.H. (Please avoid icing or condensation)	
	Conditions for transport and storage		Ambient temperature: -40 to +80°C -40 to +176°F Humidity: 5 to 85% R.H. (Please avoid icing or condensation)	
Weight		Approx. 250 g 5.82 oz	Approx. 240 g 5.82 oz	

Notes: \*1. This value can change due to the switching frequency, environmental conditions, and desired reliability level, therefore it is recommended to check this with the actual load.

\*2. The performance value applies when a varistor is connected in parallel to the coil. Please be warned that working life will be reduced when a diode is used.

\*3. at L/R ≤ 1ms

\*4. The upper operation ambient temperature limit is the maximum temperature that can satisfy the coil temperature rise value. For details, please refer to the "Automotive Relay Users Guide".

# EV Relay [Normal type]

## REFERENCE DATA

1.-(1) Ambient temperature characteristics (10A type)  
Sample: AEV110122, 3 pcs.

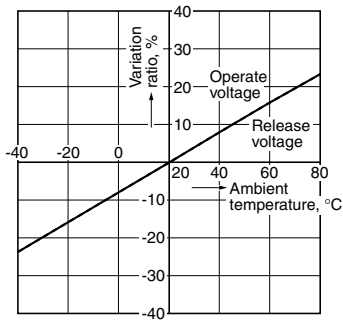

1.-(2) Ambient temperature characteristics (20A type)  
Sample: AEV52012, 3 pcs.

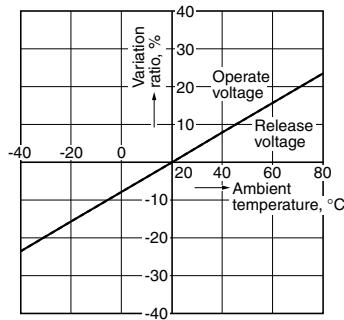

1.-(3) Ambient temperature characteristics (80A type)  
Sample: AEV18012, 3 pcs.

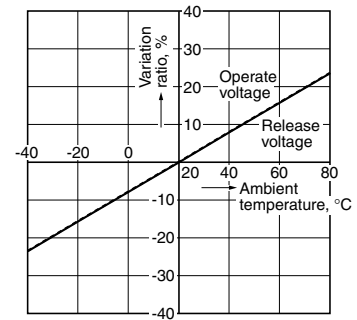

1.-(4) Ambient temperature characteristics (120A type)  
Sample: AEV14012, 3 pcs.

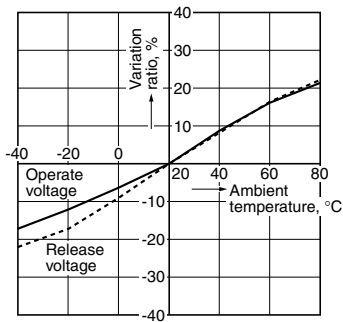

1.-(5) Ambient temperature characteristics (200A type)  
Sample: AEV17012, 3 pcs.

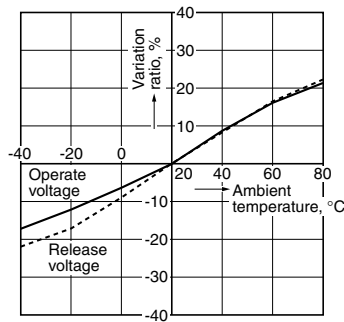

1.-(6) Ambient temperature characteristics (300A type)  
Sample: AEV19012, 3 pcs.

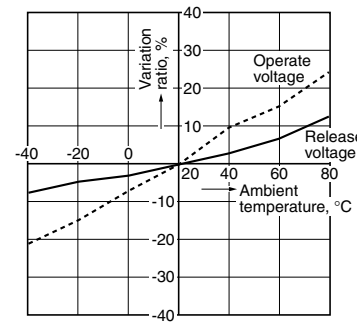

### 2. Max. value for switching capacity

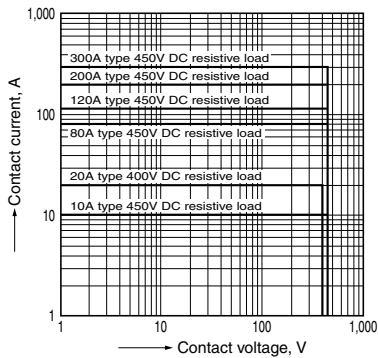

### 3. Switching life curve (Forward direction)

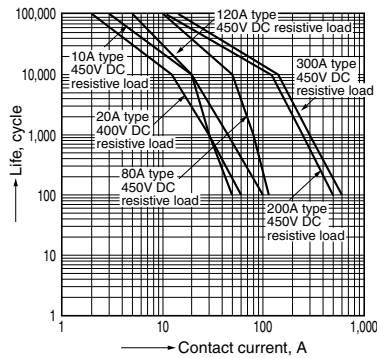

### 4. Switch-off life curve (Forward direction)

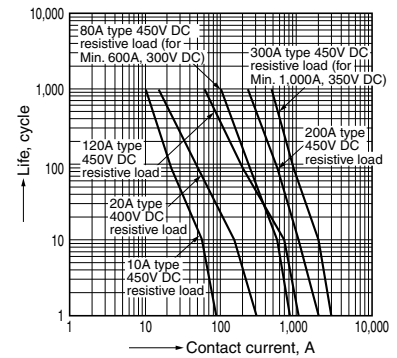

### 5. Carrying performance curve (85°C 185°F)

\*For 200 A and 300 A, at 85°C 185°F

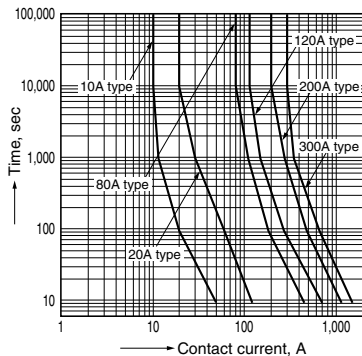



# EV Relay [Compact high short-circuit capacity type]

## REFERENCE DATA

1. Ambient temperature characteristics  
Sample: AEVG16012, 3 pcs.

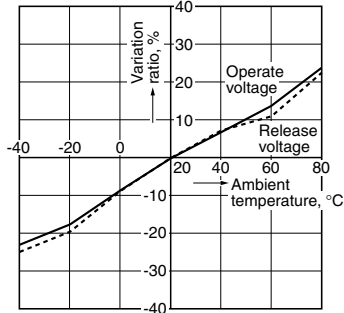

2. Max. value for switching capacity  
Sample: AEVG16012, 3 pcs.

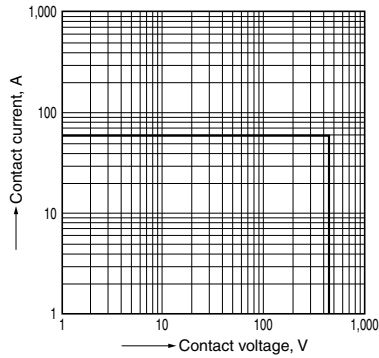

3. Switching life curve (Forward direction)  
Sample: AEVG16012, 3 pcs.

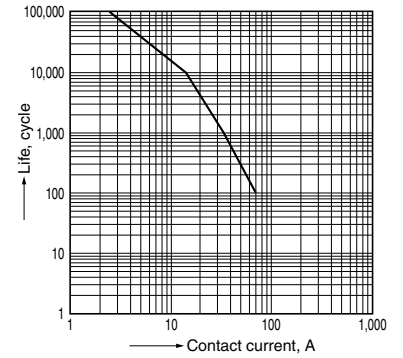

4. Switch-off life curve (Forward direction)  
Sample: AEVG16012, 3 pcs.

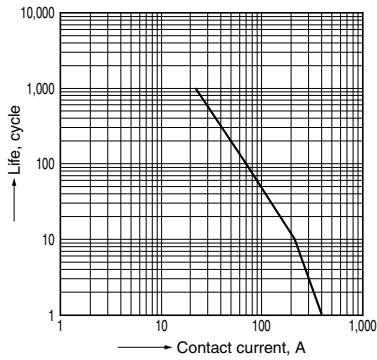

5. Carrying performance curve (80°C 176°F)  
Sample: AEVG16012, 3 pcs.

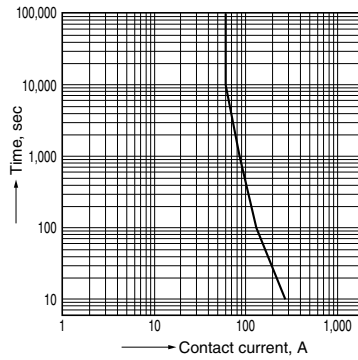

# EV Relay [Quiet type]

## REFERENCE DATA

1. Ambient temperature characteristics  
Sample: AEVS16012, 3 pcs.

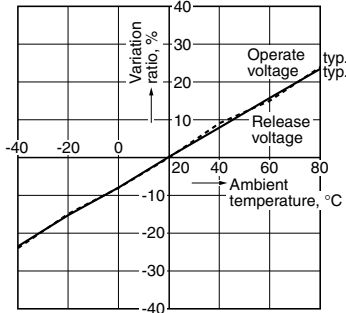

2. Max. value for switching capacity  
Sample: AEVS16012, 3 pcs.

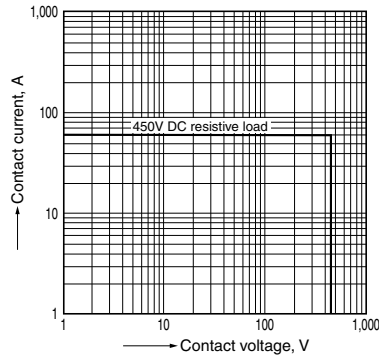

3. Switching life curve  
Sample: AEVS16012, 3 pcs.

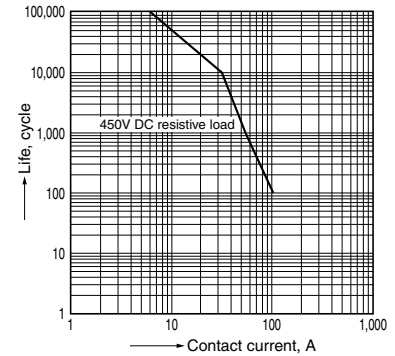

4. Switch-off life curve (Forward direction)  
Sample: AEVS16012, 3 pcs.

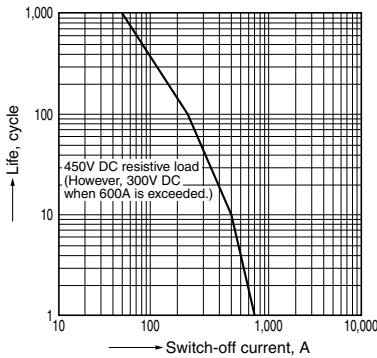

5. Carrying performance curve (80°C 176°F)  
Sample: AEVS16012, 3 pcs.

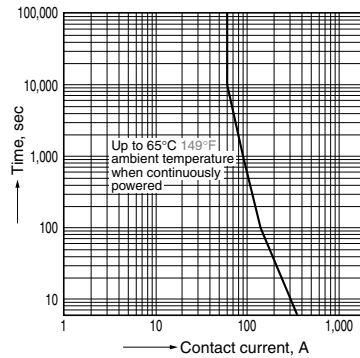

### 6.-(1)-1 Operation noise distribution (vertical type)

Measuring conditions  
Sample: AEVS16012, 50pcs  
Equipment setting: "A" weighted, Fast, Max. hold  
Coil voltage: 12V DC  
Coil connection device: 18V zener diode  
Background noise: approx. 20dB

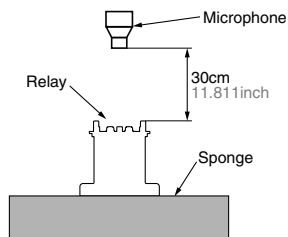

When operate

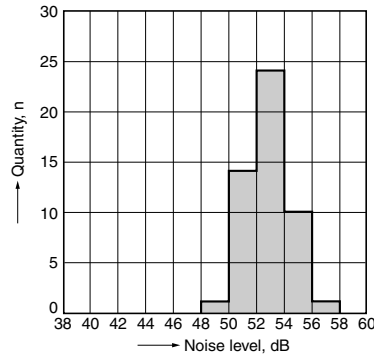

When release

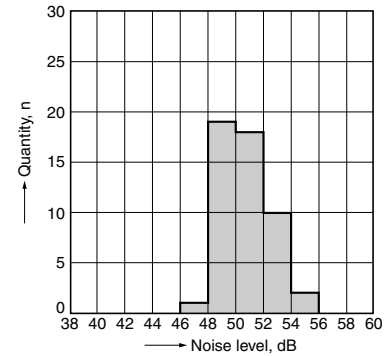

### 6.-(2)-1 Operation noise distribution (horizontal type)

Measuring conditions  
Sample: AEVS960122, 50pcs  
Equipment setting: "A" weighted, Fast, Max. hold  
Coil voltage: 12V DC  
Coil connection device: 18V zener diode  
Background noise: approx. 20dB

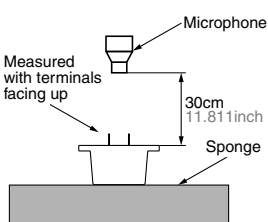

When operate

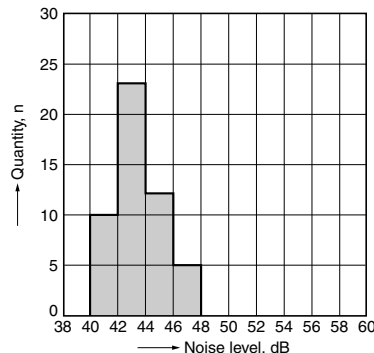

When release

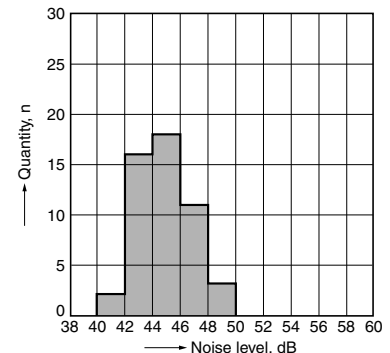

# EV Relay [Normal type]

## DIMENSIONS (mm inch)

The CAD data of the products with a **CAD** mark can be downloaded from: <http://industrial.panasonic.com/ac/e/>

### 1. 10A type

**CAD**

#### External dimensions

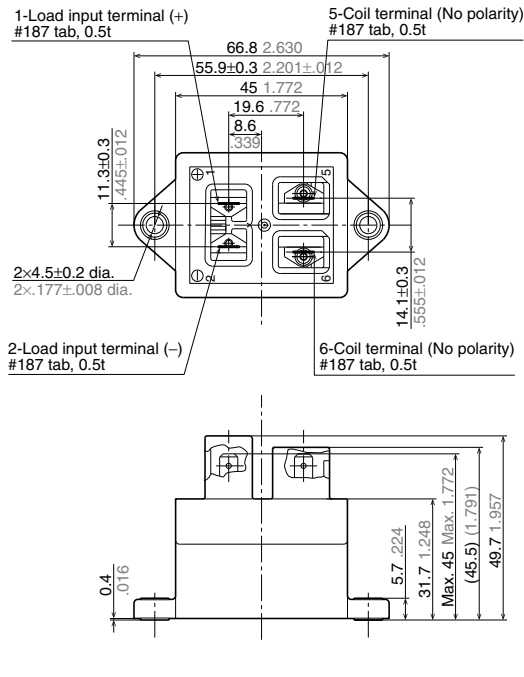

#### Schematic (TOP VIEW)

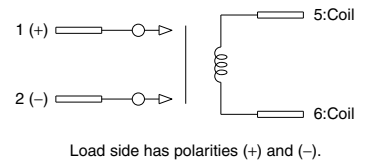

#### Mounting dimensions

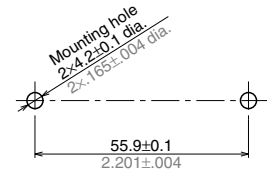

**Tolerance:**  
 Less than 10mm **.394inch:**  $\pm 0.3 \pm 0.12$   
 10 to 50mm **.394 to 1.969inch:**  $\pm 0.6 \pm 0.24$   
 More than 50mm **1.969inch:**  $\pm 1.0 \pm 0.39$

### 2. 20A type

**CAD**

#### External dimensions

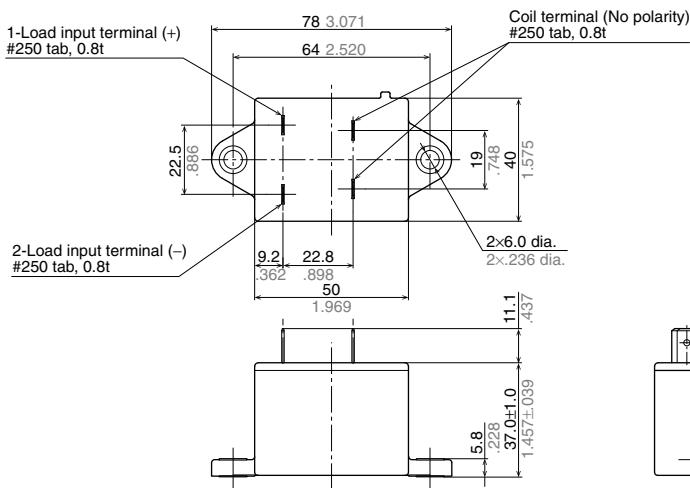

#### Schematic (TOP VIEW)

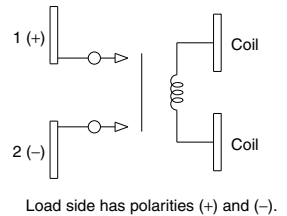

#### Mounting dimensions

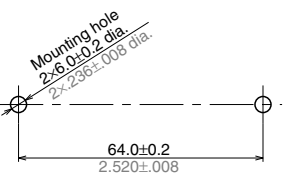

**Tolerance:**  
 Less than 10mm **.394inch:**  $\pm 0.3 \pm 0.12$   
 10 to 50mm **.394 to 1.969inch:**  $\pm 0.6 \pm 0.24$   
 More than 50mm **1.969inch:**  $\pm 1.0 \pm 0.39$

# EV (AEV, AEVG, AEVS)

## 3. 80A type

CAD

### External dimensions

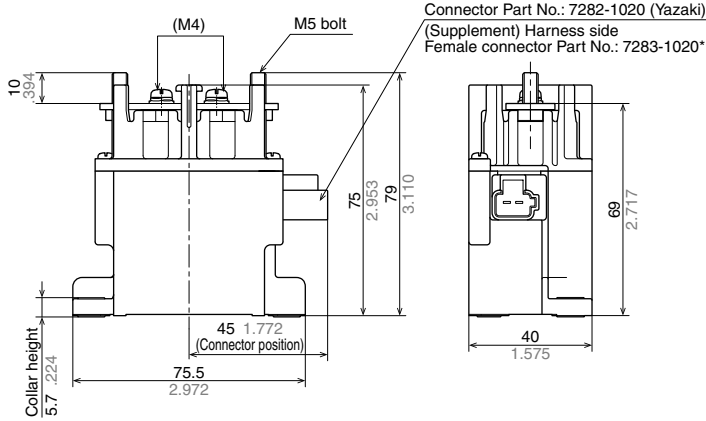
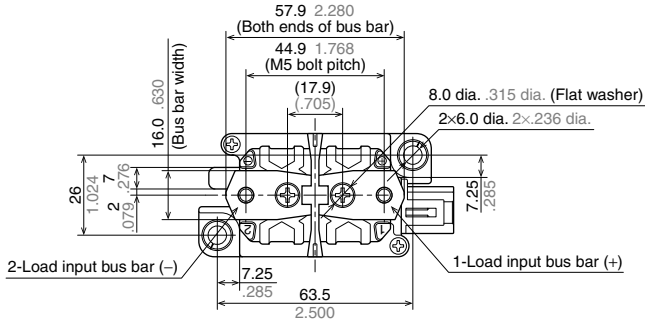

### Schematic (TOP VIEW)

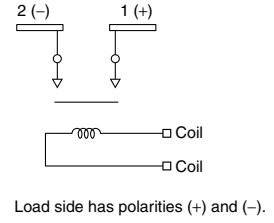

### Mounting dimensions

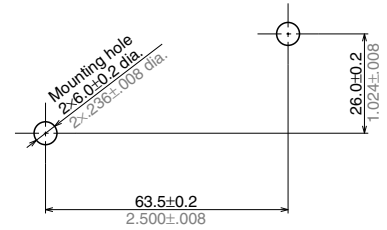

\* Separate connection of the terminal and lead wire is required.

### Tolerance:

Less than 10mm .394inch:  $\pm 0.3 \pm 0.12$   
 10 to 50mm .394 to 1.969inch:  $\pm 0.6 \pm 0.24$   
 More than 50mm 1.969inch:  $\pm 1.0 \pm 0.39$

## 4. 120A type

CAD

### External dimensions

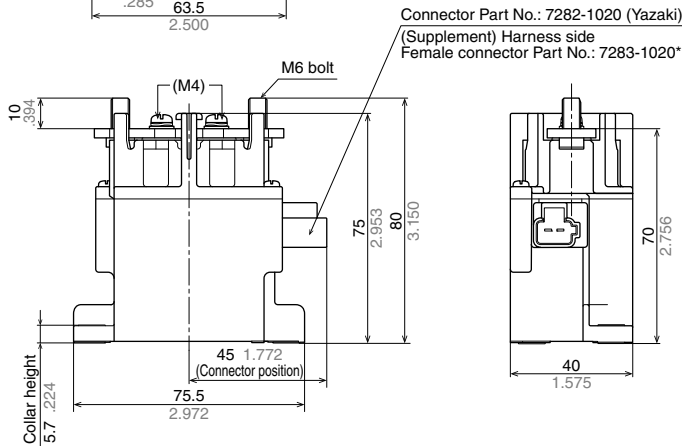
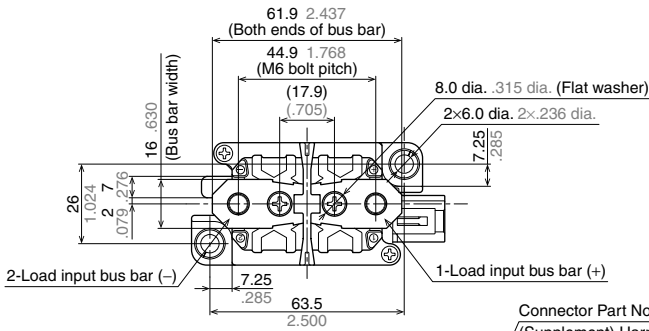

### Schematic (TOP VIEW)

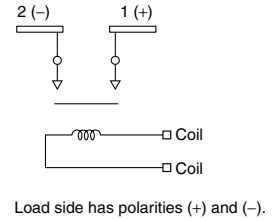

### Mounting dimensions

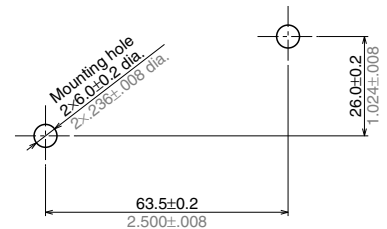

\* Separate connection of the terminal and lead wire is required.

### Tolerance:

Less than 10mm .394inch:  $\pm 0.3 \pm 0.12$   
 10 to 50mm .394 to 1.969inch:  $\pm 0.6 \pm 0.24$   
 More than 50mm 1.969inch:  $\pm 1.0 \pm 0.39$

5. 200A type

CAD

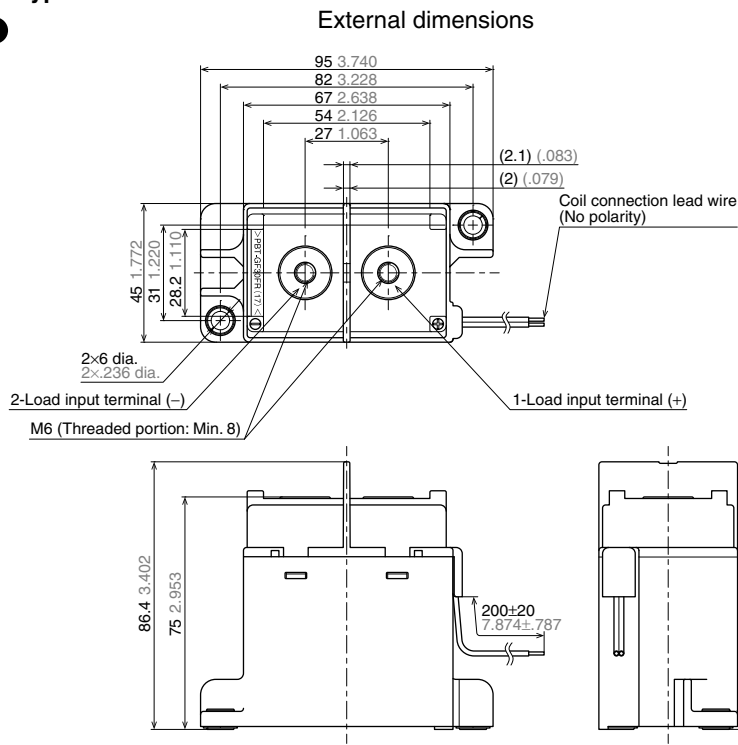

Schematic (TOP VIEW)

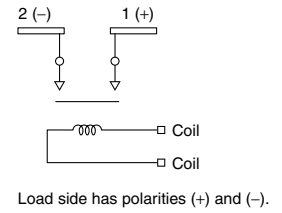

Mounting dimensions

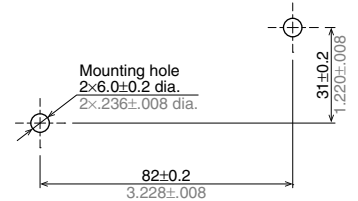

Tolerance:

- Less than 10mm .394inch: ±0.3 ±.012
- 10 to 50mm .394 to 1.969inch: ±0.6 ±.024
- More than 50mm 1.969inch: ±1.0 ±.039

6. 300A type

CAD

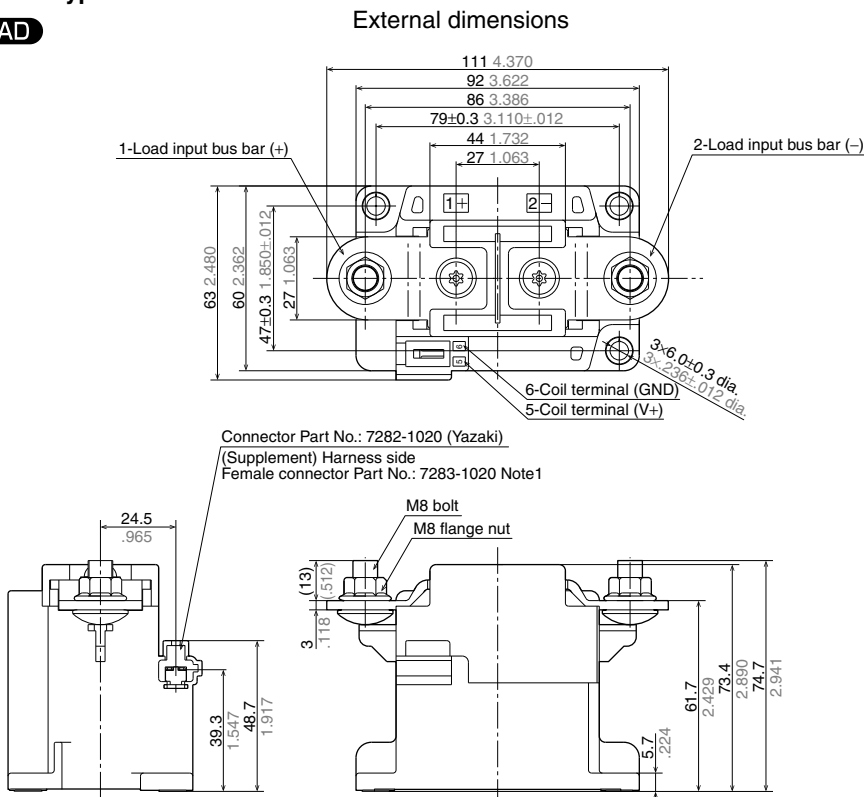

Schematic (TOP VIEW)

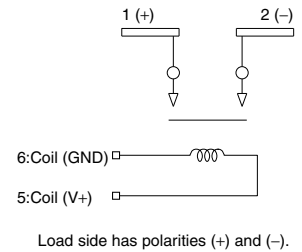

Mounting dimensions

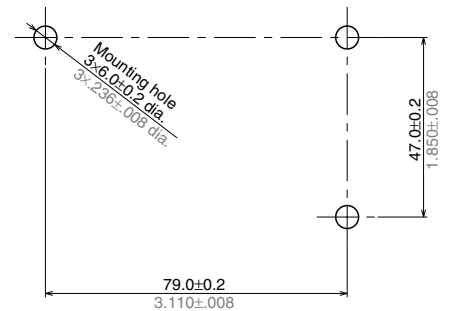

Note 1. Separate connection of the terminal and lead wire is required.

Tolerance:

- Less than 10mm .394inch: ±0.3 ±.012
- 10 to 50mm .394 to 1.969inch: ±0.6 ±.024
- 50 to 100mm 1.969 to 3.937inch: ±1.0 ±.039
- More than 100mm 3.937inch: ±1.6 ±.063

# EV Relay [Compact high short-circuit capacity type]

## DIMENSIONS (mm inch)

The CAD data of the products with a **CAD** mark can be downloaded from: <http://industrial.panasonic.com/ac/e/>

**CAD**

### External dimensions

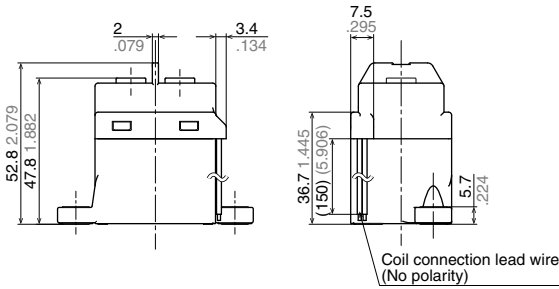
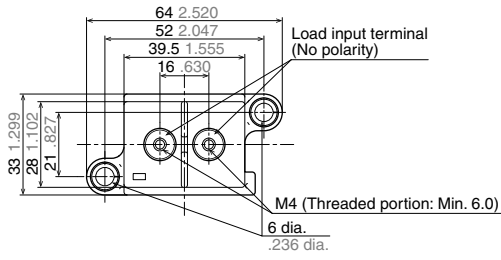

### Schematic (TOP VIEW)

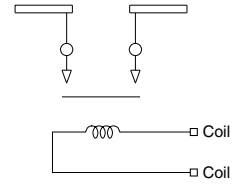

There is no polarity on the load side.

### Mounting dimensions

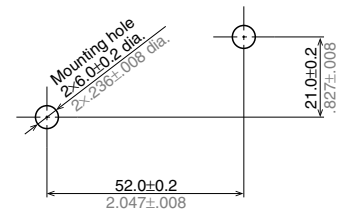

### Tolerance:

Less than 10mm .394inch:  $\pm 0.3 \pm 0.12$

10 to 50mm .394 to 1.969inch:  $\pm 0.6 \pm 0.24$

More than 50mm 1.969inch:  $\pm 1.0 \pm 0.39$

# EV Relay [Quiet type]

## DIMENSIONS (mm inch)

The CAD data of the products with a **CAD** mark can be downloaded from: <http://industrial.panasonic.com/ac/e/>

### 1. 60A Vertical type

**CAD**

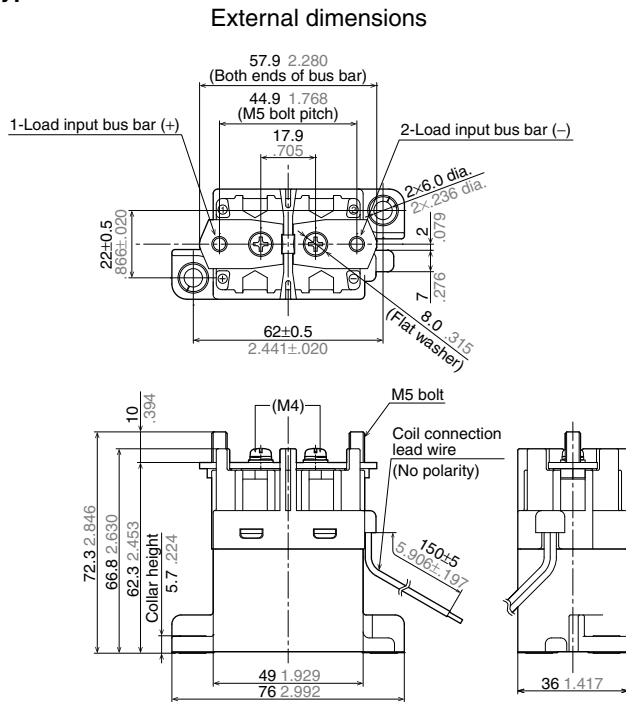

### Schematic (TOP VIEW)

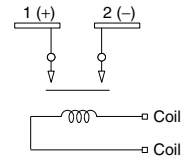

### Mounting dimensions

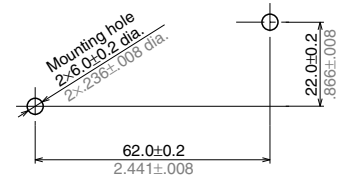

**Tolerance:**

- Less than 10mm **.394inch:** ±0.3 ±.012
- 10 to 50mm **.394 to 1.969inch:** ±0.6 ±.024
- More than 50mm **1.969inch:** ±1.0 ±.039

### 2. 60A Horizontal type

**CAD**

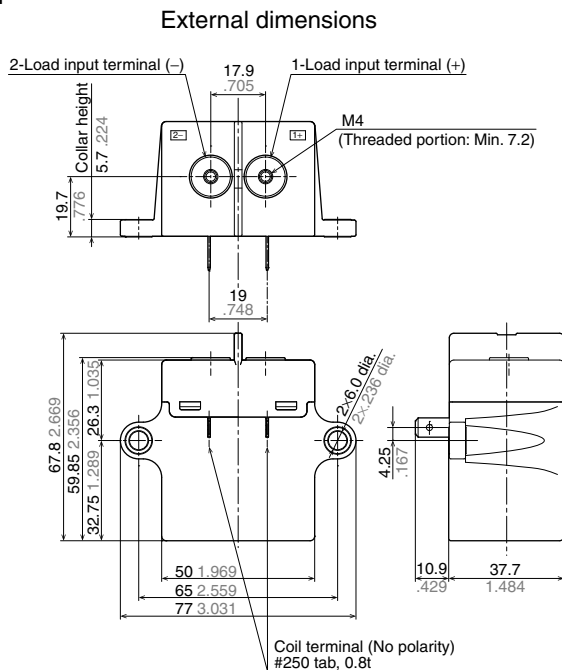

### Schematic (TOP VIEW)

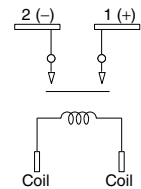

### Mounting dimensions

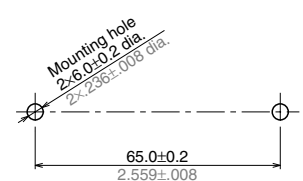

**Tolerance:**

- Less than 10mm **.394inch:** ±0.3 ±.012
- 10 to 50mm **.394 to 1.969inch:** ±0.6 ±.024
- More than 50mm **1.969inch:** ±1.0 ±.039

## NOTES

### 1. Usage, transport and storage conditions

Ambient temperature, humidity, and air pressure during usage, transport, and storage of the relay

1) Temperature:  $-40$  to  $+80^{\circ}\text{C}$   $-40$  to  $+176^{\circ}\text{F}$  (200 A and 300 A types:  $-40$  to  $+85^{\circ}\text{C}$   $-40$  to  $+185^{\circ}\text{F}$ )

2) Humidity: 5 to 85% RH

(Avoid icing and condensation.)

The humidity range varies with the temperature. Use within the range indicated in the graph below.

3) Air pressure: 86 to 106 kPa

[Temperature and humidity range for usage, transport, and storage]

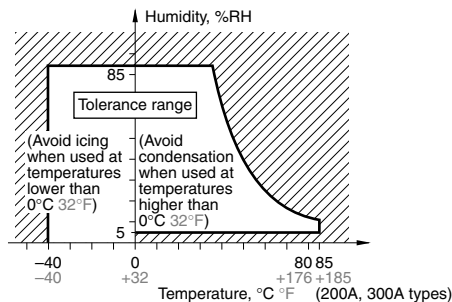

### 4) Water condensation

Water condensation occurs when the ambient temperature drops suddenly from a high temperature and humidity, or, the relay is suddenly transferred from a low ambient temperature to a high temperature and humidity. Condensation causes the failures like insulation deterioration, wire disconnection and rust etc.

Panasonic Corporation\*3 does not guarantee the failures caused by condensation.

### 5) Low-temperature, low-humidity atmosphere;

If the relay is exposed to a low-temperature, low-humidity atmosphere for a long time, its plastic parts may become brittle and fragile.

### 6) Storage

Do not keep under high-temperature and high-humidity.

### 2. Condition of tightening screw

Tighten each screw within the rated range given below.

Exceeding the maximum torque may result in breakage.

Mounting is possible in either direction.

<Relay attaching portion>

- M4 screw (for 10A type): 1.8 to 2.7 N·m
- M5 screw (for except 10A type): 3 to 4 N·m

<Main terminal attaching portion>

- M4 bolt (for Compact high short-circuit capacity and Quiet horizontal types): 2.2 to 2.8 N·m
- M5 nut (for 80A and Quiet type): 3 to 4 N·m
- M6 nut (for 120A and 200A type): 6 to 8 N·m
- M8 nut (for 300A type): 10 to 12 N·m

### 3. Electrical life

This relay is a high-voltage direct-current switch. In its final breakdown mode, it may lose the ability to provide the proper switch-off. Therefore, do not exceed the indicated switching capacity and life.

(Please treat the relay as a product with limited life and replace it when necessary.)

In the event that the relay loses switch-off ability, there is a possibility that burning may spread to surrounding parts, so configure the layout so that the power is turned off within one second.

### 4. Permeation life of internal gas

This relay uses a hermetically encased contact (capsule contact) with gas inside. The gas has a permeation life that is affected by the temperature inside the capsule contact (ambient temperature and temperature rise due to flow of electrical current). For this reason, make sure the ambient operating temperature is between  $-40$  and  $+80^{\circ}\text{C}$   $-40$  and  $+176^{\circ}\text{F}$  (200A and 300A types: Max.  $+85^{\circ}\text{C}$   $+185^{\circ}\text{F}$ ), and the ambient storage temperature is between  $-40$  and  $+85^{\circ}\text{C}$   $-40$  and  $+185^{\circ}\text{F}$ .

### 5. The coils (300A type) and contacts (except compact high short-circuit capacity type) of the relay are polarized, so follow the connection schematic when connecting the coils and contacts.

The 300A type contains a reverse surge voltage absorption circuit; therefore a surge protector is not needed.

### 6. For the 300A type, drive the coil with a quick startup.

(Built-in one-shot pulse generator circuit)

### 7. After the ON signal enters the 300A type, automatic coil current switching occurs after approximately 0.1 seconds.

Do not repeatedly turn it OFF within that 0.1 seconds interval, as doing so may damage the relay.

### 8. Be careful that foreign matter and oils and fats kind don't stick to the main terminal portion because it is likely to cause terminal portion to give off unusual heat.

Also, please use the following materials for connected harnesses and bus bars.

10A type: Min. 2 mm<sup>2</sup> nominal cross-sectional area

20A type: Min. 3 mm<sup>2</sup> nominal cross-sectional area

60A and 80A types: Min. 15 mm<sup>2</sup> nominal cross-sectional area

120A type: Min. 38 mm<sup>2</sup> nominal cross-sectional area

200A type: Min. 60 mm<sup>2</sup> nominal cross-sectional area

300A type: Min. 100 mm<sup>2</sup> nominal cross-sectional area

### 9. As a guide, the insertion strength of the plug-in terminal into the relay tab terminal should be 40 to 70N (10A type), 40 to 80N (20A and Quiet horizontal types). Please select a plug in terminal (flat connection terminal) which comply with JIS C2809-2014.

10A type: for plate thickness 0.5mm  $.020\text{inch}$  and #187 tab terminal

20A and Quiet horizontal types: for plate thickness 0.8mm  $.031\text{inch}$  and #250 tab terminal

### 10. Avoid excessive load applied to the terminal in case of installing such as a bus bar etc., Because it might adversely affect the switching performance.

### 11. Use the specified connector for the connector terminal connection (80A, 120A and 300A types).

Yazaki Corporation 7283 – 1020 or equivalent



## 12. Other cautions for use

1) Please make sure to contact our company when the product is used not in accordance with its specifications. Your nearest sales office will review the required specification from your company and perform confirmation tests in actual condition as needed. Please check "Automotive relay user's guide" for use of relays.

2) When the voltage is applied to the relay coil beyond the max. allowable voltage range, the relay operation cannot be assured. Additionally the ambient temperature and condition of your application should be considered under the worst condition of the actual usage because they may change the relay operate and release voltage.

\* It is not allowed to apply the continuous maximum voltage to the coil.

In order to obtain the specified performance, please apply the rated voltage.

3) If it includes ripple, the ripple factor should be max. 5%.

In addition, do not have a parallel connection with diode for the purpose of coil surge absorber.

If only diode is connected in parallel to the relay coil, break performance of relay cannot be assured because contact release speed becomes slower. So do not use such a circuit. Instead of diode, a Varistor (ZNR) or Zener diode (ZD) when clamp voltage is 1.5 times larger than the rated voltage (Min. 18V for the rated 12V-relay), shall be used for the absorber.

### Ex.1 When Varistor (ZNR) is used

Recommended Varistor; Energy capability: Min 1 J  
(However, please set up the value with consideration of the worst value in use condition.)

Varistor Voltage: Min. 18V at 12V DC

Min. 36V at 24V DC

### Ex.2 When Zener diode (circuit) is used

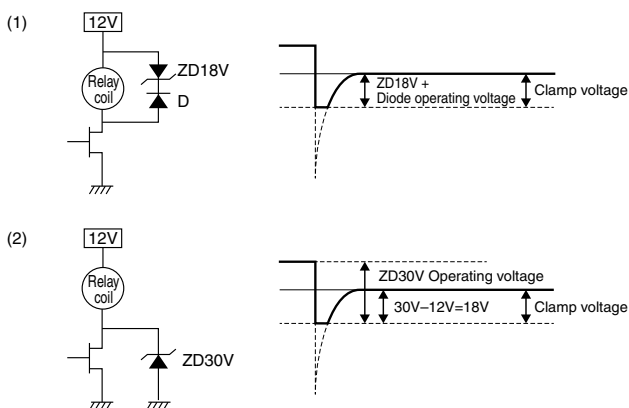

4) Lifetime is specified under the standard test conditions in JIS C 5442. (temperature 15°C to 35°C 59°F to 95°F, humidity 25%RH to 75%RH)

Lifetime is dependent on the coil driving circuit, load type, operation frequency and ambient conditions.

Check lifetime under the actual condition. Especially, contact terminals have polarity. So if the contact terminals were connected with opposite pole, the electrical life would be shortened.

5) If the relay is dropped, it should not be used again.

6) Please contact our sales representative when AC load gets applied to this relay.

Careful handling is required for switching AC load with this relay.

7) Please check the internal connection diagram in the catalog or specification, and connect the terminals correctly.

If any wrong connection is made, it may cause circuit damage by unexpected malfunction, abnormal heat, fire, and so on.

8) Please check the insulation distance between each terminal and ground.

9) Please assure the evaluation of the relay under the actual worst condition to enhance the reliability for the actual usage.

10) Please absolutely avoid the ultrasonic and high frequency vibration to the relay that adversely affects its performance.

11) Minimum switching load is the lower limit switching current under the micro-load. When the relay is used below minimum switching load, reliability becomes lower. Please use the relay beyond minimum switching load.

Additionally, minimum switching load is changed by coil drive circuit, type of load, switching frequency and environment condition.

So please confirm the reliability with actual load under the assumed actual environment.

12) As for the screws of fixing relay-body and screws of fixing contact terminal, the tightening torque must be within the specified range.

- The purpose of the tightening torque for the contact terminal is to secure adhesion force (axial force) at the fixing part and provide stable electrical connection.

Therefore, do not use the screws (bolts and nuts) which require rotation torque of locking type (prevailing torque type) because sufficient adhesion force (axial force) may not be secured.

In addition, if the locking type nut is used, an excessive torque may be applied to the case before generating of axial force and may cause breakage of the case.

- Regarding the screw for fixing relay body, please use suitable screws after adequate verification at user's side.

13) The relay should not be installed near strong magnetic fields (transformers, magnets, etc.) and should not be installed near heat source.

14) If the several relays are mounted closely or a heat-generation object is close to the relay, it may cause troubles the abnormal temperature-rise and the short insulation distance terminals outside of the relay so please assure the evaluation of the relay under the actual worst condition.

15) The relay contacts are encapsulated in an inert gas atmosphere. So, please avoid using or storing beyond the allowable ambient temperature range.

16) After that the relay has been applied with the rated voltage and current to the coil continuously and then the relay is once switched off and switched on immediately, the relay coil resistance may be increased due to the coil temperature increase.

This will result in higher operate voltage and the value will surpass the rated operate voltage value. In order to avoid this failure, the following countermeasures are recommended.

- decrease of the load current
- restriction of time to apply voltage
- restriction of operating ambient temperature, etc.

17) If an inductive load ( $L/R > 1\text{ms}$ ) is applied, add surge protection in parallel with the inductive load. If this is not done, the electrical life will be shortened and cut-off failure may occur.

18) In case using a capacitive load (C-load), please take a countermeasure as pre-charging to the capacitive load so that the inrush current will not surpass performance condition. The relay may have a contact welding without such countermeasure.

19) Use the suitable wire or bus bar according to the current. If the wire diameter is thin, maximum allowable contact current cannot be assured.

Ex.) Carrying current; 120A: diameter of 38mm<sup>2</sup> (minimum) (for wire at the load side)

20) Take care to disconnect from the power supply when wiring.

## EV (AEV, AEVG, AEVS)

---

- 21) The tension load applied to the coil lead wire when wiring should be max. 10N. In addition, take care not to bend at the lead wire pullout portion when wiring or apply a stationary load to the lead wire after wiring to avoid failure of the relay such as breaking of wire.
- 22) The relay satisfies water resistance level of JIS D 0203 R2. Please take any countermeasures additionally if it is installed in the place where higher water resistance level is required.
- 23) Do not use this product in such atmosphere where any kind of organic solvent (as benzene, thinner and alcohol) and the strong alkali (as ammonia and caustic soda) may be adhered to this product.
- 24) Be careful that oils and foreign matter do not stick to the main terminal part because it is likely to cause a terminal part to give off unusual heat.
- 25) Do not make additional manufacturing upon the relay housing.
- 26) Maximum overcurrent value in this specification is limited as single operation only. In the case of multiple operation, this relay may cause malfunction by heating. So, please confirm the temperature / operation using your application.  
In the case of multiple operation, please stop applying the over current to secure the relay's temperature under the maximum ambient temperature.
- 27) When applying current which includes precipitous changes or ripple, the relay may generate buzzing sound.  
Therefore, please confirm with the actual load.

---

**For general cautions for use, please refer to the “Automotive Relay Users Guide”.**

---

Please contact .....

**Panasonic Corporation**

Electromechanical Control Business Division

■ 1006, Oaza Kadoma, Kadoma-shi, Osaka 571-8506, Japan  
[industrial.panasonic.com/ac/e/](http://industrial.panasonic.com/ac/e/)

**Panasonic**<sup>®</sup>

©Panasonic Corporation 2017